

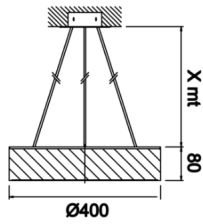

| | |
|----------------------------------|--|
| Armatür Grubu | Sarkıt |
| Montaj Tipi | Sarkıt |
| Armatür Rengi | RAL 9005 - RAL 9006 - RAL 9010 |
| Gövde | Alüminyum Ekstrüzyon |
| Optik | Opal Difüzör |
| Işık Kaynağı | LED |
| Elektriksel Koruma Sınıfı | CLASS II |
| IP | 40 |
| IK | 02 |
| Çalışma Sıcaklığı | -20°C / +40°C |
| Işık Akısı | 13095 lm / 16320 lm / 22850 lm / 4370 lm / 6195 lm |
| Tüketim Gücü | 120 W / 150 W / 40 W / 51 W / 96 W |
| Armatür Verimliliği | 124,5 lm/W |
| Renksel Geri Verim (CRI) | >80 |
| Işık Renk Sıcaklığı (CCT) | 2700K/3000K/4000K/6500K |
| Renk Toleransı | < 3 SDCM |
| Driver Tipi | On/Off |
| Driver Markası | Tridonic |
| LED Markası | Samsung |
| Giriş Gerilimi / Frekans | 220-240 V AC 50/60 Hz |
| Güç Faktörü | >0.9 |
| Surge | 1kV |
| THD (AKIM) | >%20 |
| LED ömrü | >50.000 saat |
| Opsiyon | On-Off / Dali / 1-10V / Acil Durum Kitli |

Teknik Çizim



Fotometrik Eğri

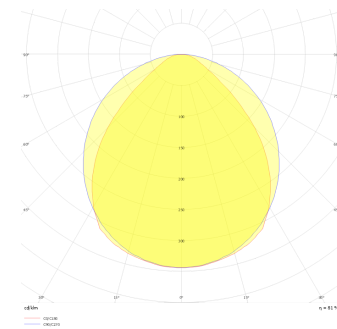

Drums



Sarkıt Armatür

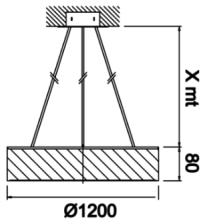
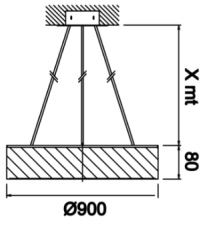
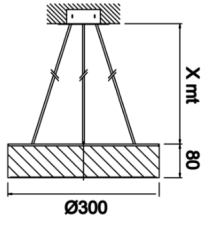
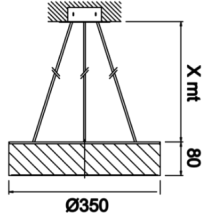

Fotometrik Eğri

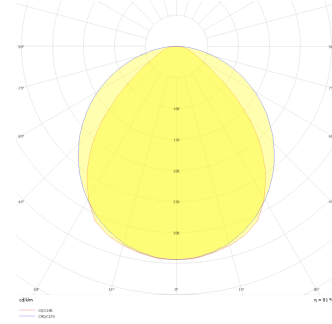

Drums



Sarkıt Armatür

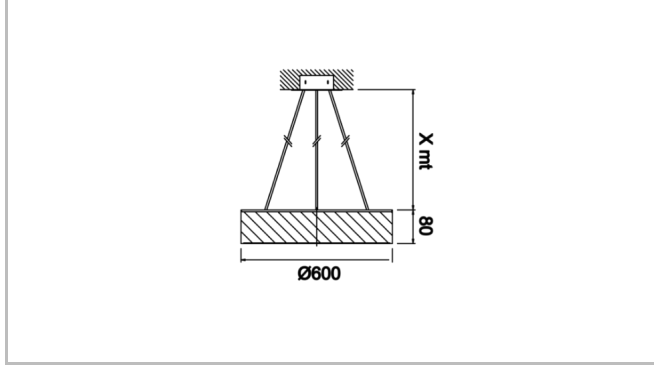

| Sipariş Kodu | Ürün Kodu | Güç (W) | Işık Akısı (LM) | CRI | CCT (K) | Optik | Ölçüler (mm) |
|--------------|--------------------------------------|---------|-----------------|-----|---------|-------------------|--------------|
| | DRM 045 008 035P 8040 10 99 OP 40 00 | 40 | 4370 | >80 | 4000 | 120° Opal Difüzör | Ø50 |
| | DRM 060 008 048P 8040 10 99 OP 40 00 | 51 | 6195 | >80 | 4000 | 120° Opal Difüzör | Ø60 |
| | DRM 090 008 109P 8040 10 99 OP 40 00 | 96 | 13095 | >80 | 4000 | 120° Opal Difüzör | Ø90 |
| | DRM 120 008 150P 8040 10 99 OP 40 00 | 120 | 16320 | >80 | 4000 | 120° Opal Difüzör | Ø120 |
| | DRM 150 008 180P 8040 10 99 OP 40 00 | 150 | 22850 | >80 | 4000 | 120° Opal Difüzör | Ø150 |